

Spreading Wings S800 EVO User Manual

V 1.00

2013.07.02 Revision

Disclaimer

Thank you for purchasing this DJI product. Please regularly visit the S800 EVO web page at www.dji-innovations.com, which is updated regularly. Product information, technical updates and manual corrections will be available on this web page. Due to unforeseen changes or product upgrades, the information contained in the manual is subject to change without notice.

Read this disclaimer carefully before using this product. By using this product, you hereby agree to this disclaimer and signify that you have read them fully. Please strictly follow the manual to assemble and use the product. The manufacturer and seller assume no liability for any resulting damage or injury arising from the operation or use of this product.

DJI is registered trademark of DJI Innovations. Names of product, brand, etc., appearing in this manual are trademarks or registered trademarks of their respective owner companies. This product and manual are copyrighted by DJI Innovations with all rights reserved. No part of this product or manual shall be reproduced in any form without the prior written consent or authorization of DJI Innovations. No patent liability is assumed with respect to the use of the product or information contained herein.

Profile

S800 EVO is a multi-rotor designed for aerial photograph which integrates reinforced mechanical structures, stabilized dynamical system and high-efficiency power supply. Integrated designs make assembly and configuration become especially easy and fast; retractable landing gear, foldable propellers and collapsible GPS Mount are conveniently portable for optimal user experiences. Retractable landing gears and vibration dampers coordinate to create omnidirectional aerial view and high quality photograph. Combined with professional DJI multi-rotor autopilot system S800 EVO will achieve hovering, cruising and other steady flight elements, which can be applied for aerial photography and other aero-modeling activities.

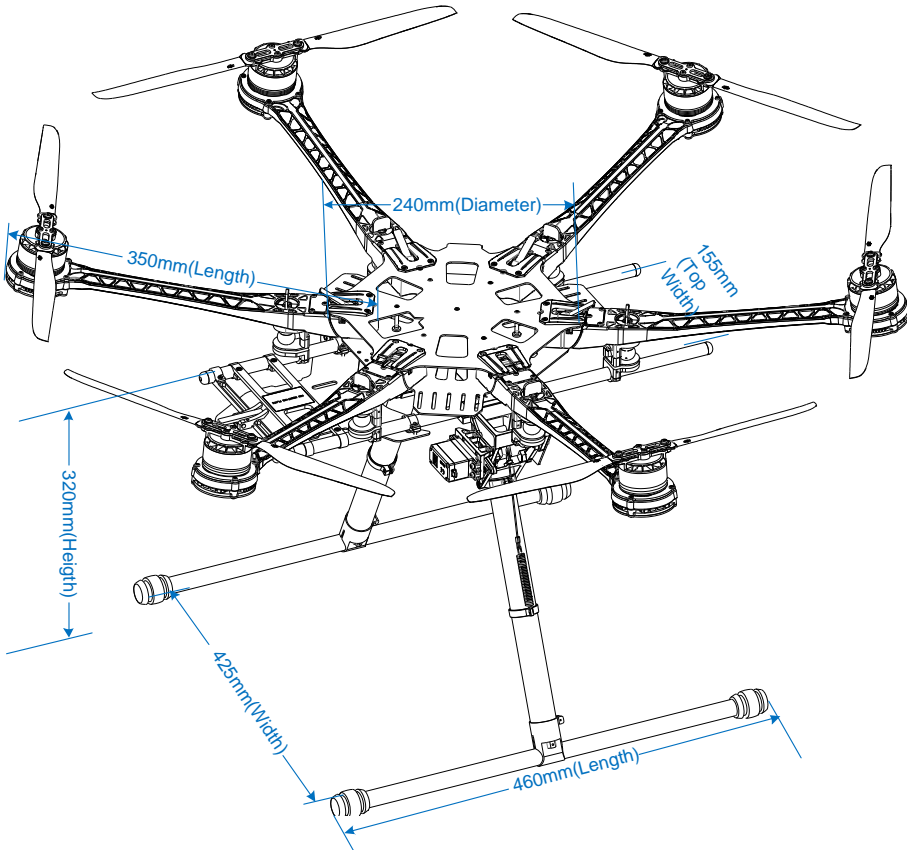







Contents

Disclaimer.....	2
Profile.....	3
Contents.....	4
Product Usage Cautions	5
In The Box.....	6
Tools Needed.....	6
Center Frame Wiring.....	7
Attach Electric Equipment to Center Frame.....	8
Mount Frame Arms.....	10
Mount Landing Gear.....	12
1 Assembly & Connection.....	12
2 Travel Calibration.....	13
3 Transmitter Setting.....	14
4 Usage.....	14
5 Mount Battery Bracket.....	16
Assembly.....	17
Install the IMU Mount (Optional).....	18
Appendix.....	19
ESC Sound.....	19
ESC LED.....	19
Specifications.....	20
FAQ (Trouble Shooting).....	21
Solder ESC.....	21
Spare Parts Listing.....	22

Product Usage Cautions

When flying, the fast rotating propellers may cause serious damage(s) and injuries. Therefore, please fly with a high safety in mind at all time.

Assembly Cautions

- (1) Mount the GPS Module with a bracket, to avoid interference with the power board of center frame.
- (2) For IMU mounting, make sure the arrow direction marking on the IMU is pointing to the aircraft nose.
- (3) The receiver is strongly recommended to be attached under the bottom board of center frame, and the head of antenna is downward without any obstacle. Otherwise the aircraft may be out of control, since the wireless signal may be lost.
- (4) Mount the arms correctly.
 - a) Center frame  ↔  Arm 
 - b) Center frame  ↔  Arm 
- (5) For removing screws in the bottom board, please proceed with cautious, avoiding damages. Do not remove any other screws fixed with glue.
- (6) Notice matching the indications is very important, please pay attention to them.







Flight Cautions

- (1) With DJI WKM autopilot system, make sure the output signal of WKM F1-F2 and M1-M6 are all normal, to avoid serious damages and injuries.
- (2) Keep flying the multi-rotor a distance from people, building, high-voltage lines, tall trees, water, etc.
- (3) Make sure to use 6S LiPo battery for power supply.
- (4) Do not get close to or touch the working motors and propellers, which will cause serious injury.
- (5) Do not over load the multi-rotor.
- (6) Make sure the propellers and the motors are installed correctly and firmly before flying.
- (7) Make sure all parts of product are in good condition before each flight. Do not fly with wore or broken parts.
- (8) Strongly recommend you to use DJI parts as much as possible.

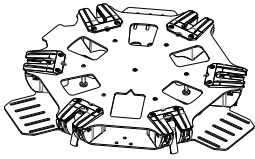
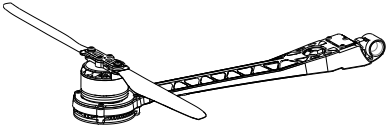
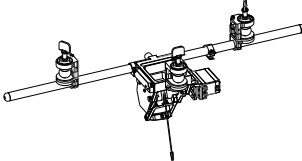
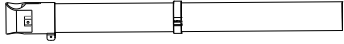
Others

- (1) If you have any problem you cannot solve, please contact your dealer or DJI customer service.

In The Box

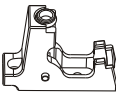
<p>Center Frame×1</p> 	<p>Frame Arm×6</p> 
<p>Retracting Mechanism×2</p> 	<p>Landing Gear Support Tube ×2</p> 
<p>Base Pipe×2</p> 	<p>H Frame Connection Pipe×1, Spring×2</p> 
<p>Package of 3-PIN Servo Cable ×1</p> 	<p>Silicone Rubber Damper ×4</p> 
<p>Package of Battery Tray×1</p> 	<p>Package of IMU Mount×1</p> 
<p>GPS Fixed Seat×1</p> 	<p>Screw Package for Frame×1 Screw Package for Landing Gear×1</p>
<p>Out of The Box Guidance ×2</p>	

Tools Needed

<p>2.0mm Hex Wrench, 2.5mm Hex Wrench</p>	<p>For mounting screws.</p>
<p>Thread Locker</p>	<p>For fastening screws.</p>
<p>Nylon Cable Tie</p>	
<p>Scissors</p>	<p>For binding devices and wires.</p>
<p>Diagonal Cutting Pliers</p>	
<p>Foam Double Sided Adhesive Tape</p>	<p>For fixing receiver, controller and other modules.</p>

Center Frame Wiring

The top board is a power distribution board, and the bottom board is for loading autopilot system components.

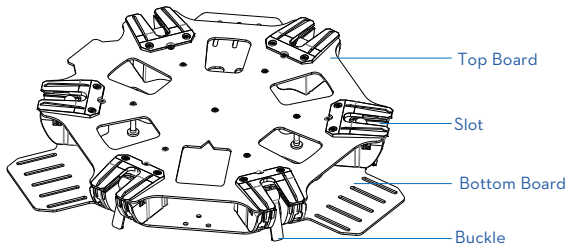

Top Board

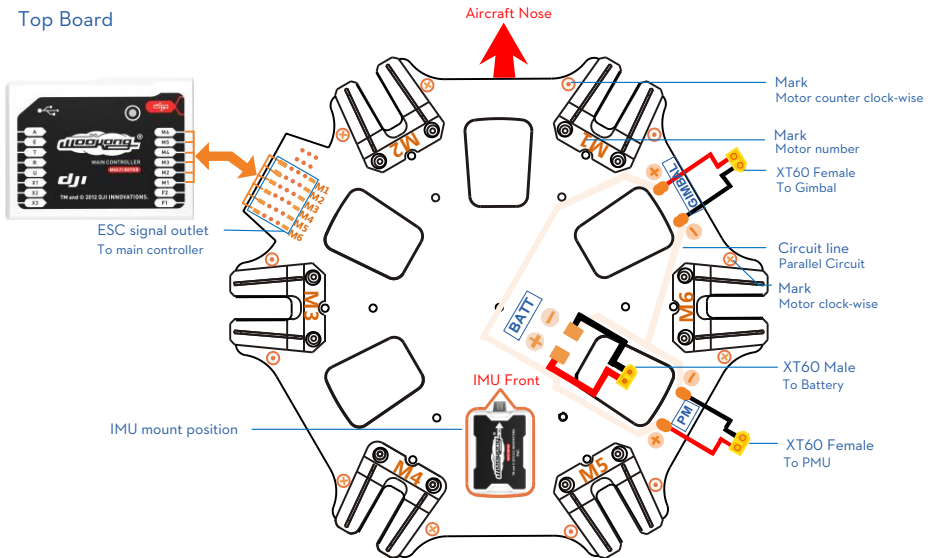

Notes:

- (1) For IMU mounting, make sure the arrow direction marking on the IMU is pointing to the aircraft nose.
- (2) Connect the 3-pin connectors (M1-M6) of servo cable from WKM M.C. to ESC signal socket (M1-M6) on center frame markings accordingly.
(WKM M.C. M1 ↔ ESC signal socket M1, , WKM M.C. M6 ↔ ESC signal socket M6)

Tips:

- (1) The main battery power leads, gimbal and PMU leads are on the bottom surface of the top board.
- (2) Markings and stand for the propeller rotation direction. means clock-wise, and means counter clock-wise.
- (3) If other lead connector is required, please cut the original connector and solder on the new one. (But NOT Recommend.)

Attach Electric Equipment to Center Frame

1. (Fig.1) Remove the screws in the bottom board.
2. (Fig.2) Attach the IMU module into IMU position in the center frame. Ensure the IMU casing is out of touching the top board edge, as vibration can cause IMU mal-function.
3. (Fig.2) Please attach DJI Autopilot System parts onto the bottom board (not including GPS modules).
4. (Fig.2) Connect the Autopilot System and receiver. Please refer to DJI [WKM User Manual](#) for details.
5. (Fig.3) Please fix all the screws to bottom board, and use adequate thread locker.
6. (Fig.4) Attach the GPS Fixed Seat to the top board (near to the M3), then mount the GPS Module to the GPS Fixed Seat with a bracket.
7. Configure Autopilot System. Please refer to DJI [WKM User Manual](#).

Note:

- (1) Make sure to mount the IMU module at the IMU position first, and the mount orientation is correct.
- (2) Mount the GPS with a bracket, to avoid interference from center frame power board.
- (3) Make sure the USB port of the M.C. is pointing outwards for easy access.
- (4) Please wire neatly. Make sure the wires will not be cut by the edge of frames.
- (5) Install the screws with appropriate strength to prevent damage threads.
- (6) Watch out clamping fingers when folding the GPS Bracket.

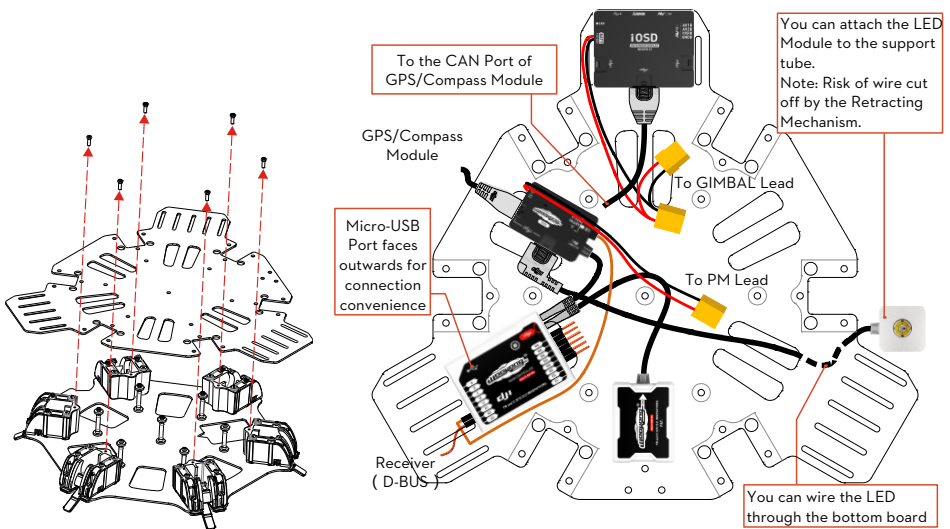

Fig.1 Remove the screws

Fig.2 Attach the Autopilot System

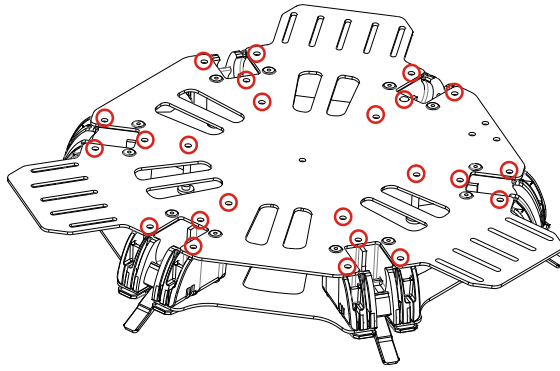

Fig.3 Fix the screws

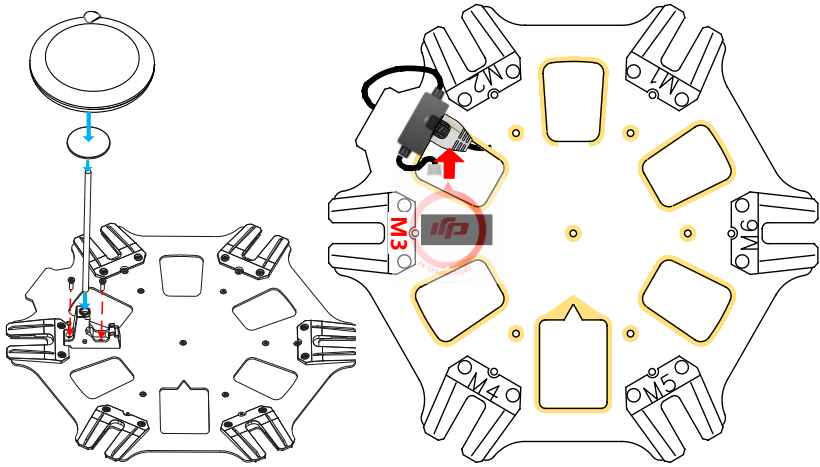

Fig.4 Mount the GPS Fixed Seat and GPS module

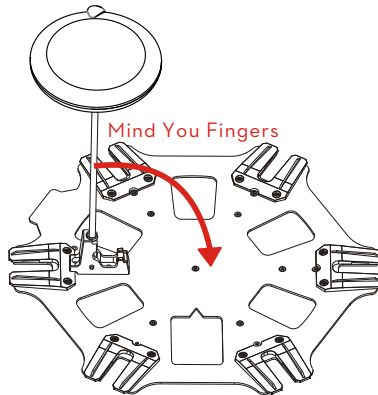
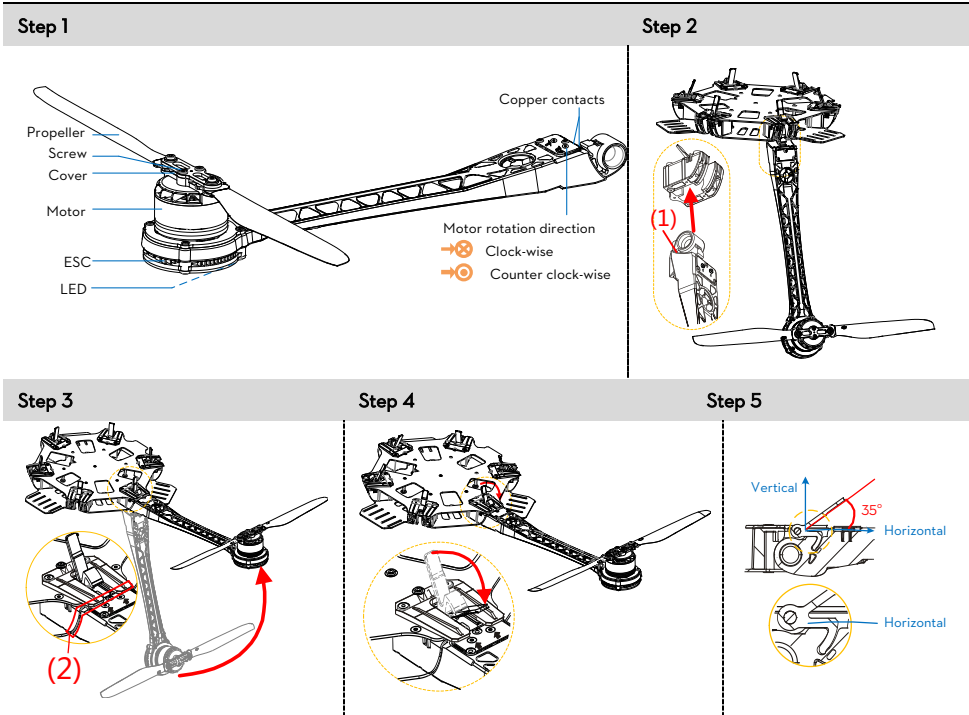









Fig.5 Note of folding the GPS Bracket

Mount Frame Arms



Step1: Check the arms.

- (1) Make sure the copper contacts are in good condition without bend or severe wear.
- (2) Make sure the propellers are without crack, and screws in propeller cover tight.
- (3) Make sure the motors are mounted firmly, and rotate freely.
- (4) We recommend you to mount the arms with red propeller cover to M1 and M2 to indicate the nose of aircraft.
- (5) Distinguish the marks  and  on the arms.
 - Arm   Center frame 
 - Arm   Center frame 

Step2: Insert the frame arm into center frame vertically.

Step3: Slowly rotate the frame arm upward until positioned completely.

Step4: Press down the buckle to lock the arm. Make sure the arm does not move.

Step5: Make sure the buckle is pressed down correctly, about 35° under normal circumstances.

Notes:

- (1) Please add some lubricant at the position (1) if it is hard to press down the buckle.
- (2) Slowly rotate the frame arm to prevent from breaking the copper contacts.

- (3) Please refer to (2) to make sure the arm is perfectly positioned.
- (4) Make sure to use appropriate strength to press down the buckle correctly.
- (5) Do not hot plug arms.

Tips:

- (1) LED is on after motor start.

Step 6 Double Check

Arms ①② are aircraft nose, arms ④⑤ are aircraft tail. See from top, motors on arms ①③⑤ rotate counter clockwise; motors on arms ②④⑥ rotate clockwise.

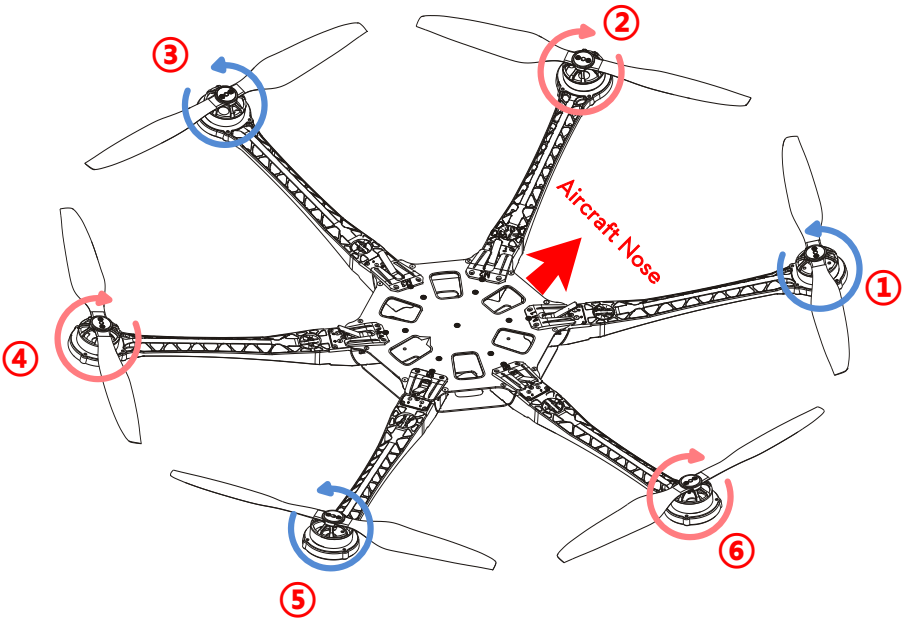

Mount Landing Gear

By using a 2-position switch of R/C transmitter, you can control the landing gear to retract remotely.

1 Assembly & Connection

The part with the control board attached is defined as left, and the other part is right. Make sure to make a distinction between the left and the right servos.

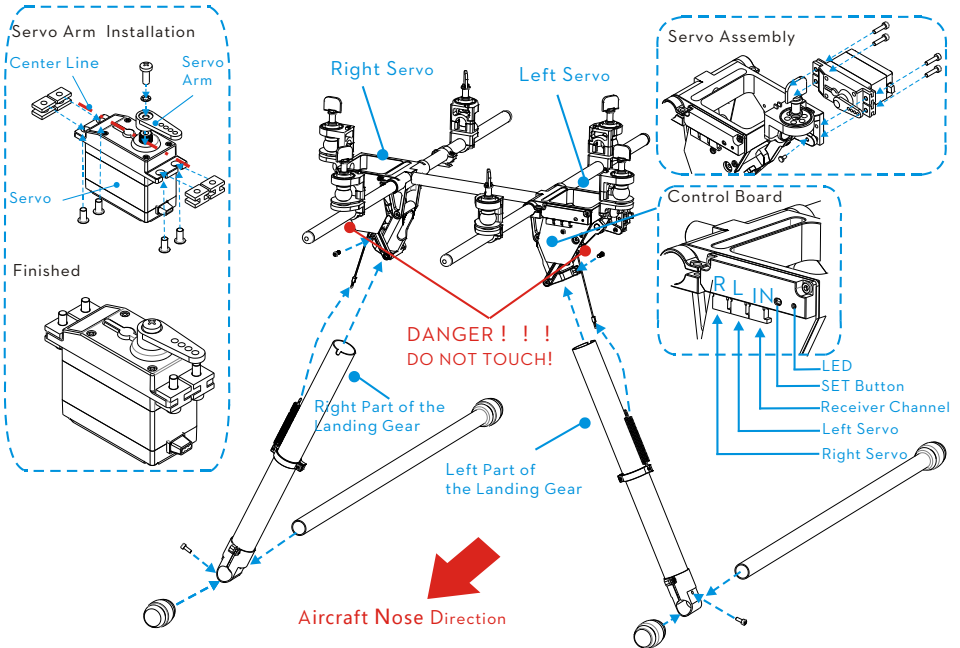

step1: Servo Installation (If the servos have already been installed, please skip this step.)

1. (Shown in the Fig) Define and mark the two HS-7954SH servos from Hitec as left servo and right servo.
2. Connect the left servo to the [L] port on the control board, and the right servo to the [R] port.
3. Keep pressing the SET button with aid of a small tool, and then power on. You will see the yellow LED beside SET button flashes quickly, and then wait until the servos have finished their position initialization.
4. Make sure the servo arm is parallel to the servo's center line.
5. Power off, assemble the left and right servos to the left and the right parts of the landing gear.

Tips: If you use your own servos, it is recommended to use the dedicated programmer from Hitec to enlarge the servo travel from 120° to 150°, and then install servos by the above steps. Servos from DJI have been enlarged servo travel.

step2: Mechanical Assembly

-
1. Assemble the left and right parts respectively, and then fix the screws at the joints with appropriate thread locker.
 2. Connect the left and right parts with connecting rod.
 3. For safety reasons, make sure to connect the springs to both parts.

step3: Electrical Connections

1. Plug the cables from the servos into the correct ports on the control board. Make sure the right servo is connected to the **[R]** port, and the left servo to the **[L]** port.
 2. Connect the required 2-position switch of R/C receiver to the **[IN]** port.
-

2 Travel Calibration

If the Landing Gear you got has been installed with the servos, please skip this step. Otherwise, calibrate the system using the following procedures.

-
1. For safety reasons, please keep your hands away from any link mechanism to avoid injury.
 2. Make sure the **[R]**, **[L]** and **[IN]** connections are correct and firmly connected.
 3. Hang the Landing Gear in the air during calibration, as the landing gear will move.
 4. Keep pressing the SET button using a small tool and power on. You can see the LED flashes YELLOW quickly, and then press the SET button once again. The system begins auto calibration with the indication of the LED flashing YELLOW slowly. **DO NOT** obstruct any moving part during auto calibration.
 5. The left-part is calibrated, the left link mechanism first moves up then moves down automatically. Then the right-part is calibrated, the right link mechanism first moves up then moves down automatically.
 6. After calibration, both left and right parts are in the **[Lower]** position, and the LED is solid GREEN on. Then the landing gear will work normally.

Notes:

- (1) If the LED is solid YELLOW on during calibrating, it means that there is something wrong with the calibration, please re-do the Servo Installation of the Assembly & Connection section, since the servo arm might be installed with a wrong angle.
 - (2) Please avoid any obstruction during calibrating. If the landing gear is blocked from moving, please recalibrate the landing gear by the above steps.
 - (3) If the **[R]** and **[L]** servo cables are reversed, the travel will not be measured correctly. Please connect correctly and recalibrate the landing gear using the above steps.
-

3 Transmitter Setting

Select a 2-position switch (default setting is OK) of Transmitter as the control input of the landing gear, and then make sure the corresponding port of receiver is connected to the **[IN]** port on control board.

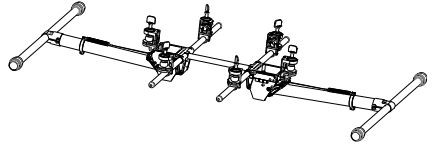
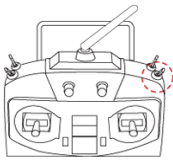

Fig. 1



Retracted : Toggle the switch to this position to retract the landing gear (Fig.1)



Lower : Toggle the switch to this position to lower the landing gear (Fig. 2)

Tips:

- (1) If the switch of Transmitter has FailSafe function, set the FailSafe value to the **[Lower]** position, so that the landing gear will be in **[Lower]** status when the receiver enters FailSafe mode, to land the aircraft safely.
- (2) To avoid false switch triggering, you can use the slide lever or other trim as the landing gear's control switch.

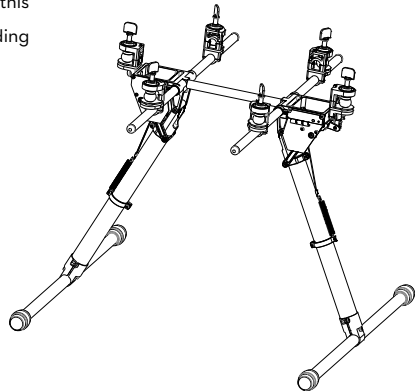

Fig. 2

4 Usage

The landing gear can be used by following the steps below after assembly & connection.

1. Make sure the transmitter & receiver batteries are fully charged.
2. Toggle the switch to the **[Lower]** position, and then turn on the transmitter.
3. Make sure the **[R]**, **[L]** and **[IN]** connections are correct and firmly connected.
4. Make sure the Landing Gear is at the **[Lower]** position, and then power on the system. If the green LED is solid on, then this is a normal start. If the LED flashes GREEN slowly, please re-calibrate the system according to the procedure of Travel Calibration.
5. Make sure to toggle the switch to the **[Retracted]** position ONLY AFTER you takeoff the aircraft.
6. When the aircraft is landing, please toggle the switch to the **[Lower]** position for a safe landing.

Tips

- (1) The system will turn off the servo power temporarily within 3 seconds after the landing gear has reached the target position.
- (2) When powering on the system, if the Transmitter switch is at the **[Retracted]** position, which is the unsafe signal for the landing gear, the LED will quickly flash RED. Toggle the switch to the **[Lower]** position.
- (3) If there is an abnormal signal or no signal input into the **[IN]** port the LED will slowly flash RED. Please check the receiver and the connections.
- (4) If the power consumption of servos is too large during usage, the LED will be solid RED on. If this status lasts more than 4 seconds, the landing gear will lower and the LED will flash GREEN slowly. Please re-calibrate the system.

LED Indicator

System works normally	
Hasn't been calibrated	
Need re-calibration	
Wrong calibration	
Enter the calibration mode	
System is calibrating	
Motor stall	
Input signal is unsafe when power on the Transmitter	
Input signal is abnormal	

Specifications

Parameter	Range	Parameter	Range
Working Voltage	3S-6S (LiPo)	Input Signal	PWM (High-Pulse Width 800us-2200us)
Working Current	Max 1A@6S	Output Signal	PWM(Mid Position is 1520us) in 90Hz
Working Temperature	-20-70°C	Output Voltage	6V
Total Weight	875g	Servo Travel	150° (Minimum120°)

5 Mount Battery Bracket

Step1: Mount the retaining clip and the bracket, fix screws (but not tighten).

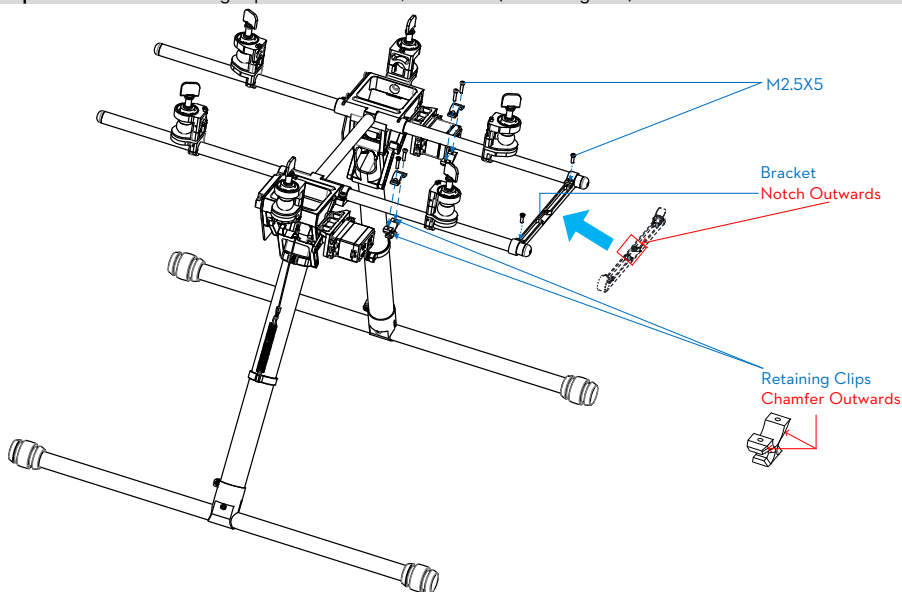

Step2: Place the battery mounting board and adjust its position, and then tighten all screws.

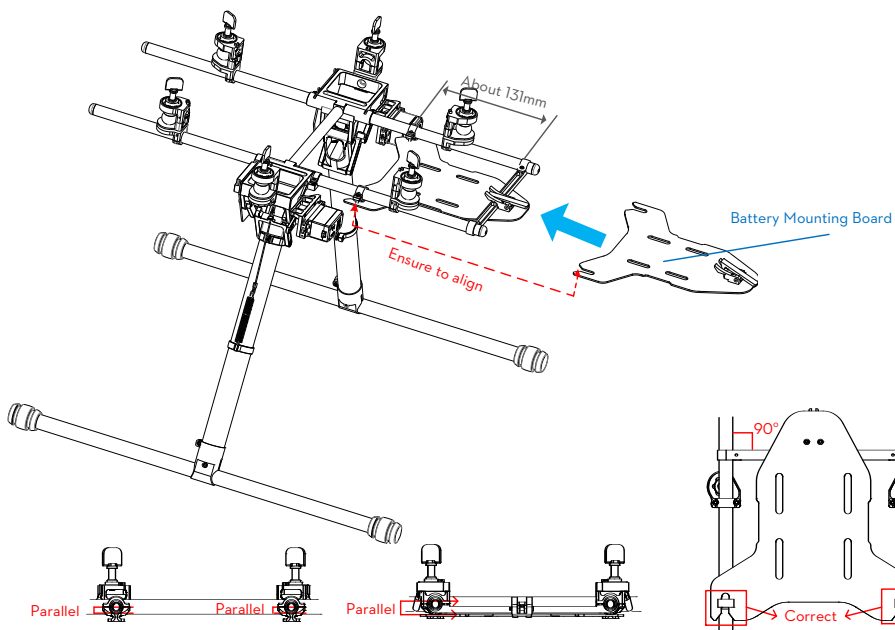

Assembly

Assembly

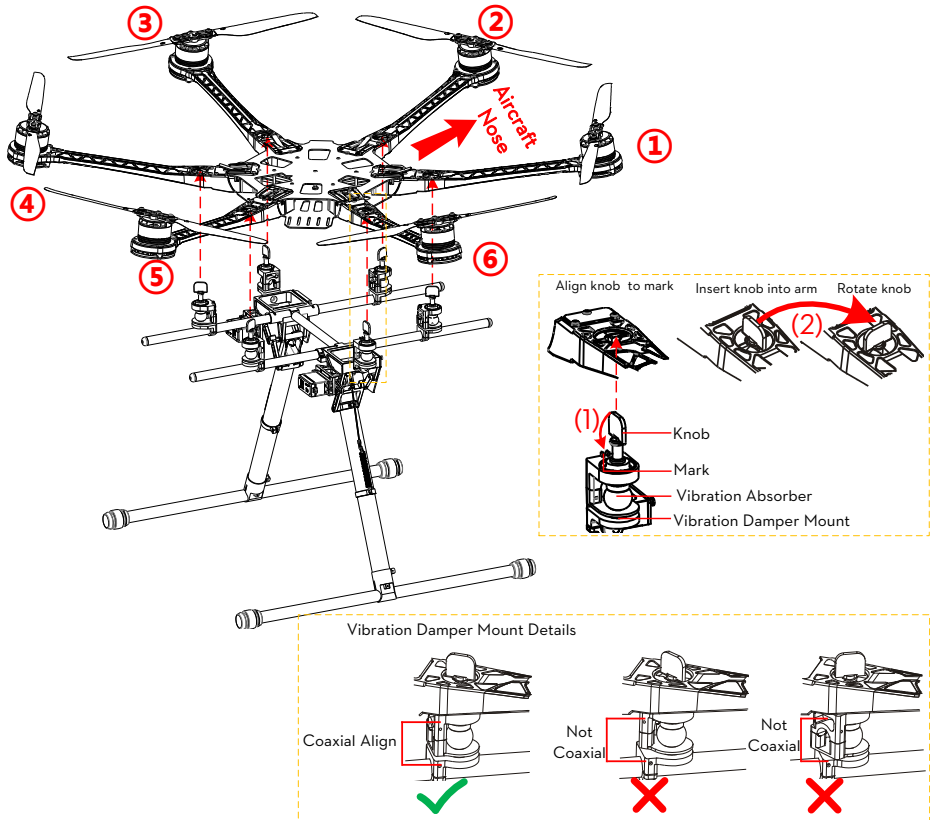

1. Align all knobs on H frame to the marks; refer to fig (1).
2. Lie frame and Landing Gear horizontally, insert knobs into arms ③ and ⑥ first, and then adjust to insert the others into the arms.
3. Make sure the Vibration Damper Mount is correct, and then rotate the knob to the end, as fig (2) shown.

Notes:

- Ensure all knobs on the H frame aligned to the marks, and they would go through the arms successfully.

Install the IMU Mount (Optional)

If you wish to achieve a smooth and steady flight, carry out the following procedures to install the IMU Mount.

1. (Fig.1) Remove the screws to dismount the Battery Bracket.
2. (Fig.2) Fix the IMU Mount and remount the Battery Bracket.
3. (Fig.3) Adjust the IMU Mount and the Battery Bracket, and then fix all the screws.
4. (Fig.4) Attach the IMU Module; make sure that the arrow on LOGO is pointing to the aircraft nose.

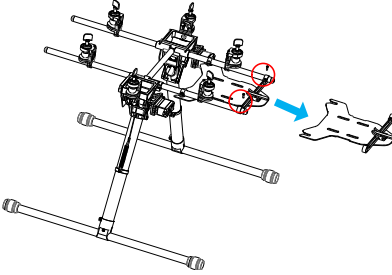

Fig.1

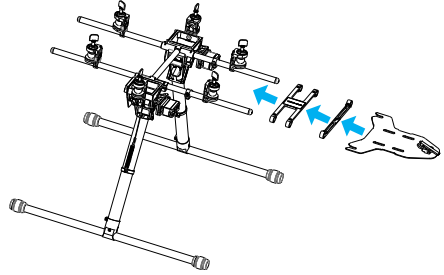

Fig.2

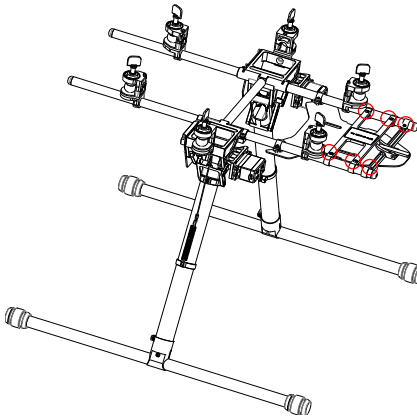

Fig.3

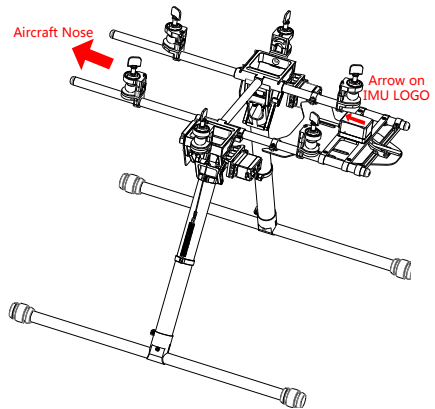

Fig.4

Appendix

ESC Sound

ESC State	Sound
Ready	♪1234567--B--B
Throttle stick is not at bottom	BBBBBB...
Input signal abnormal	B-----B-----B...
Input voltage abnormal	BB---BB---BB---BB...

ESC LED

ESC State	LED
Standby	Off
Motor rotating	Solid Red or Green On
Motor rotating at full throttle position	Solid Yellow On

Tips:

DJI ESCs are specially designed for multi-rotors. When use with DJI autopilot systems, you do not have to setup any parameters or calibrate travel range.

Specifications

Frame	
Diagonal Wheelbase	800mm
Frame Arm Length	350mm
Frame Arm Weight (with Motor, ESC, Propeller)	356g
Center Frame Diameter	240mm
Center Frame Weight	550g
Landing Gear Size	460mm(Length)×425mm(Width)×320mm(Height) (Top width: 155mm)
Retractable Landing Gear Weight (Including Battery Tray)	1050g
Motor	
Stator Size	41×14mm
KV	400rpm/V
Max Power	500W
Weight (with Cooling Fan)	158g
ESC	
Current	40A OPTO
Voltage	6S LiPo
Signal Frequency	30Hz ~ 450Hz
Drive PWM Frequency	8KHz
Weight (with Radiators)	35g
Propeller (Foldable)	
Material	Carbon Fiber
Size	15×04 in
Weight	10g
Flight Parameters	
Takeoff Weight	6.0Kg - 8.0Kg
Total Weight	3.7Kg
Power Battery	LiPo (6S, 10000mAh-15000mAh, 15C(Min))
Max Power Consumption	3000W
Hover Power Consumption	800W(@ Takeoff Weight 6.7Kg)
Hover Time	Max: 20 min (@15000mAh&6.7KgTakeoff Weight)
Working Environment Temperature	-10 ~ +40 °C

FAQ (Trouble Shooting)

Solder ESC

Make sure to solder the thick wires and fine wires correctly, when solder ESC to frame arm.

Clockwise and counter clockwise motor should be soldered to ESC correctly by different color order.

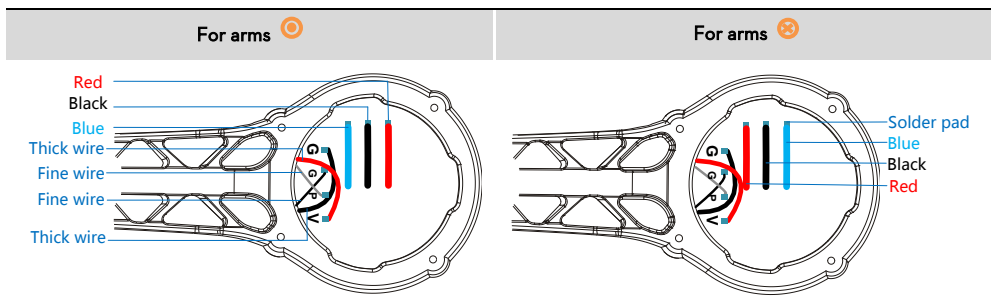

Spare Parts Listing

If S800 EVO needs component replaced, please refer to the following diagram to identify the component NO., and then make a purchase of corresponding package. Each package includes screws needed. The Components Number is defined as below.

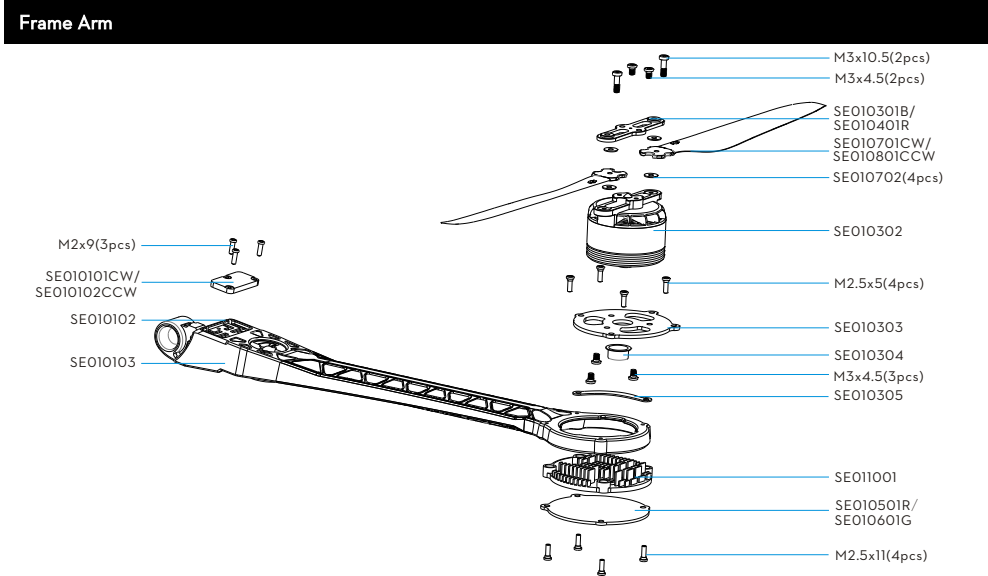
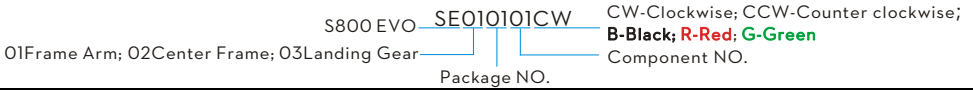

Package NO.	Name	Components Number
1	Frame Arm (Clockwise)	SE010101CW, SE010102, SE010103, M2x9
2	Frame Arm (Counter Clockwise)	SE010102CCW, SE010102, SE010103, M2x9
3	Motor with black cover	SE010301B, SE010302, SE010303, SE010304, SE010305, M2.5x5, M3x4.5
4	Motor with red cover	SE010401R, SE010302, SE010303, SE010304, SE010305, M2.5x5, M3x4.5
5	ESC with Red Led	SE010501R
6	ESC with Green Led	SE010601G
7	Foldable 15' Propeller CW	SE010701CW, SE010702, M3x10.5, M3x4.5
8	Foldable 15' Propeller CCW	SE010801CCW, SE010702, M3x10.5, M3x4.5
9	Washer of Propeller	SE010702
10	ESC Radiator	SE011001

Center Frame

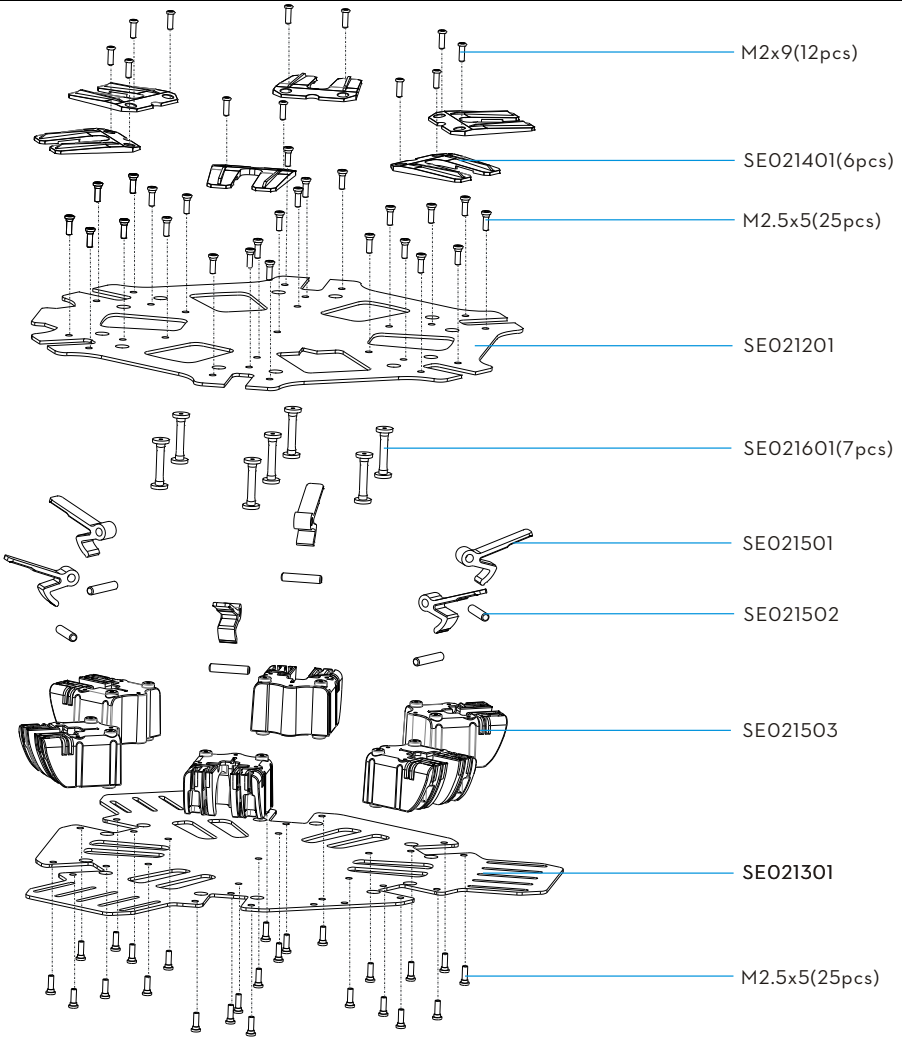

Package NO.	Name	Components Number
11	Center Frame	SE021201、SE021301、SE021401、SE021501、SE021502、SE021503、SE021601、M2x9、M2.5x5
12	Center Frame Top Board	SE021201、M2x9、M2.5x5
13	Center Frame Bottom Board	SE021301、M2.5x5
14	Top Board Cover	SE021401、M2x9
15	Arm Mounting Bracket	SE021501、SE021502、SE021503、M2x9、M2.5x5
16	Aluminum Brace for Center Frame	SE021601、M2.5x5

Landing Gear

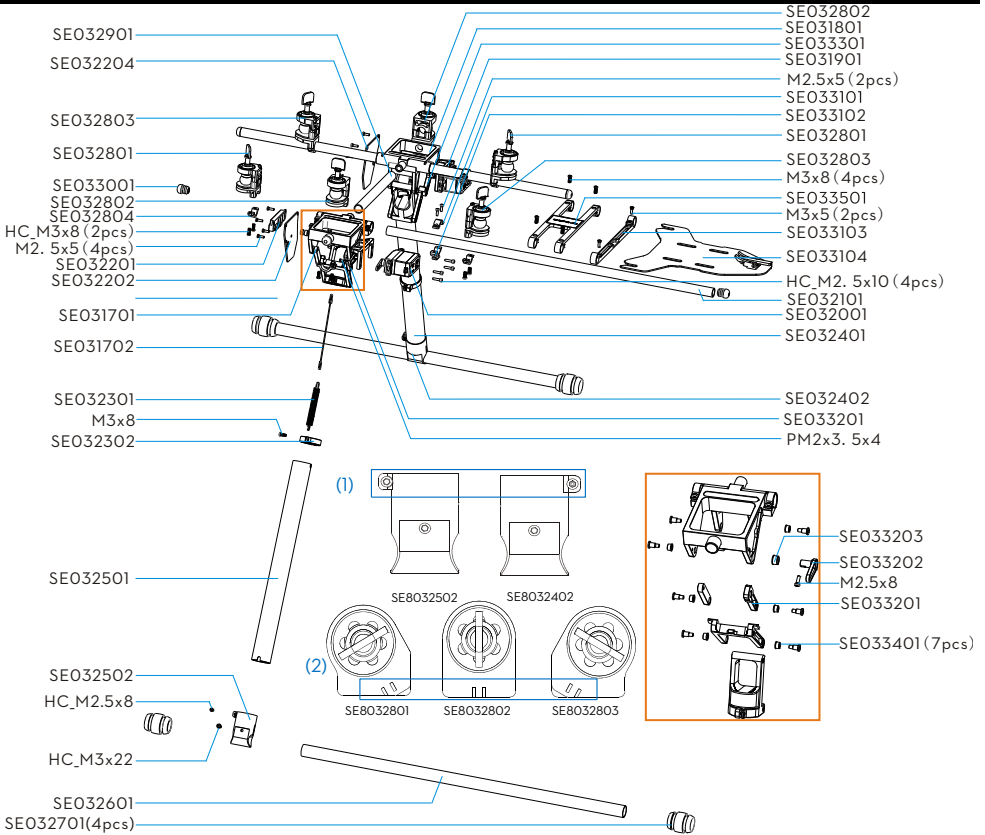

Notel: (1) Left Support Tube right Support Tube are different; (2) Left set, middle set and right set of Damping Unit are different.

Package NO.	Name	Components Number
17	Retractable Module(Left)	SE031701、 SE031702
18	Retractable Module(Right)	SE031801、 SE031702
19	HITEC Servo (Right)	SE031901、 HC_M2.5x10
20	HITEC Servo (Left)	SE032001、 HC_M2.5x10
21	Carbon Pipe of H-Frame	SE032101、 HC_M2.5x8
22	Control Board	SE032201、 SE032202、 SE032203、 SE032204、 M2.5x5
23	Spring	SE032301、 SE032302、 SE031702、 M3x8
24	Support Tube (Right)	SE032401、 SE032402、 M3x8、 HC_M2.5x8、 HC_M3x8
25	Support Tube (Left)	SE032501、 SE032502、 M3x8、 HC_M2.5x8、 HC_M3x8

26	Base Pipe	SE032601、 SE032701
27	Silicone Rubber Damper	SE032701
28	Damping Unit (Set)	SE032801、 SE032802、 SE032803、 SE032804、 HC_M3x8
29	Aluminum Pipe of H-Frame	SE032901
30	Silicone Rubber of H-Frame	SE033001
31	Battery Tray	SE033101、 SE033102、 SE033103、 SE033104、 M2.5x5、 M3x5
32	Steering arm of Retractable Module(Left)	SE033201、 SE033202、 SE033203、 M2.5x8
33	Steering Arm of Retractable Module(Right)	SE033301、 SE033202、 SE033203、 M2.5x8
34	Shaft Sleeve of Retractable Module	SE033401
35	IMU Mount	SE033501 、 M3x8

Others



Package NO.	Name	Components Number
36	GPS Fixed Seat	SE033601
37	Screws Package	M3x8(10pcs)、 HC_M2.5x10(10pcs)、 M2.5x5(30pcs)、 M2x9(10pcs)、 M3x4.5(10pcs)、 M2.5x8(5pcs)、 M2.5x11(10pcs)、 M3x 10.5(15pcs)、 HC_M3x8(10pcs)、 HC_M2.5x8(10pcs)、 HC_M3x22(5pcs)
38	Blade Holder	SE033801