



## B6 Ultimate

Professional Balance Charger/Discharger



## Instruction Manual

## TABLE OF CONTENTS

---

Introduction.....	02
Special features.....	05
Warning and safety notes.....	09
Program flow chart.....	14
Lithium polymer balance charge program connection diagram.....	16
Initial parameter setup (users set up).....	18
Lithium battery (Lilon/LiPo/LiFe) program.....	21
Charging lithium battery in the charge mode.....	22
Charging lithium battery in the balance mode.....	23
Charging lithium battery in the fast charge mode.....	24
Charging lithium battery in the storage mode .....	25
Discharging of lithium battery.....	26
Charging NiCd/NiMH battery in the charge mode.....	27
Discharge of NiCd/NiMH battery.....	28
Charge/discharge and discharge/charge cycle of NiCd/NiMH battery.....	29
Charging Pb (lead-acid) battery in the charge mode.....	30
Discharging of the Pb battery.....	31
Storage data program.....	32
Load data program.....	33
Various information in the program.....	34
Warning and error message.....	35
Recommended accessories.....	36
Conformity declaration.....	37
Maximum circuit power chart.....	38
Specification.....	40
Commonly used terms.....	41
Warranty and service.....	42

## INTRODUCTION

---

Congratulations on your choice of the iMAX B6 Ultimate digital intelligent charger from SKYRC Technology Co., Ltd. You are now the owner of a compact charger with battery management and integral balancer.

The unit is simple to use, but the operation of a sophisticated automatic charger such as the iMAX B6 Ultimate does require some knowledge on the part of the user. These operating instructions are designed to ensure that you quickly become familiar with its functions.

It is therefore important that you read right through the Operating Instructions, Warning and Safety Notes before you attempt to use your new automatic charger for the first time. We hope you have many years of pleasure and success with your new battery charger.

iMAX B6 Ultimate employs the circuit that features output power of 200 watts. It can charge or discharge up 18 cells of NiCd/NiMH or 6 series of Lithium batteries with maximum current of 10A. B6 Ultimate has an individual cell voltage balancer, so it does not require any balancer separately when charging Lithium batteries (LiPo/LiIon/LiFe) for voltage balancing.

The fan cooling system is so smart and efficiently. The fan speed is controlled by internal temperature sensor.

Please BE SURE to read these instructions and Warning and Safety Notes before you use the charger for the first time.

It can be dangerous to mis-handle batteries and battery chargers, as there is always a risk of batteries catching fire and exploding.

## INTRODUCTION

Please read this entire operating manual completely and attentively before using this product, as it covers a wide range of information on operating and safety. Or please do use this product in company with a specialist!

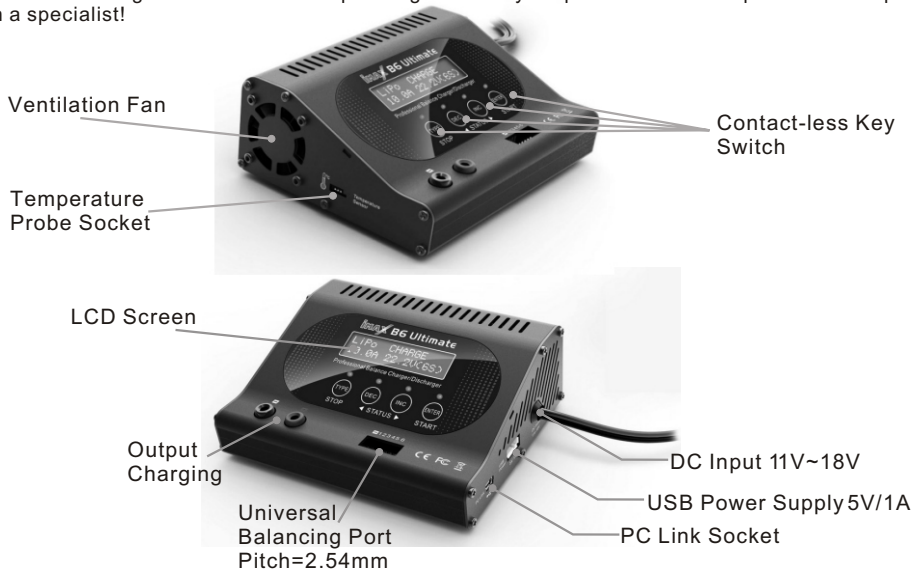

## Connection Diagram

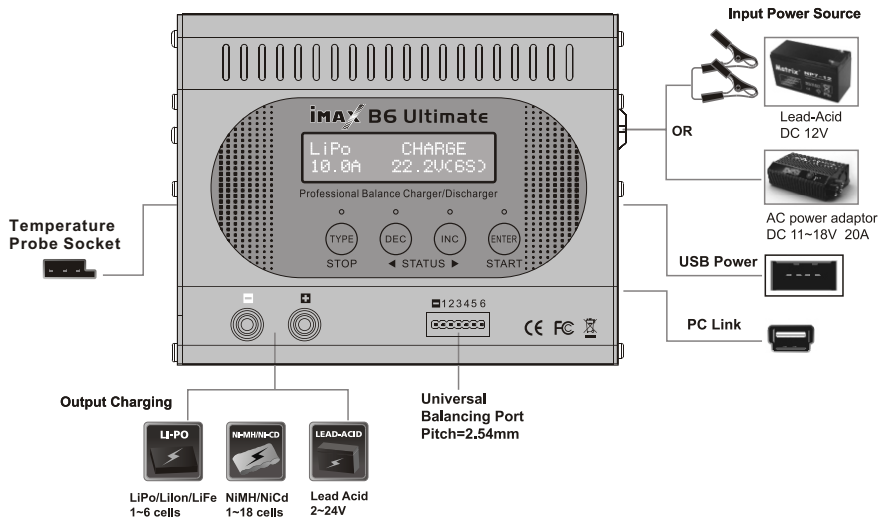

## SPECIAL FEATURES

---

### Set contents



1. iMAX B6 Ultimate Charger
2. XHAdaptor
3. Temperature Probe
4. Crocodile Clip Charging Cable
5. 18AWG Wire Charging Cable
6. Charger Monitor Program Disk
7. USB Cable
8. Plug-in Battery Clamps

### Special features

#### Optimized operating software

iMAX B6 Ultimate features the so-called AUTO function that set the feeding current during the process of charging or discharging. Especially for Lithium batteries, it can prevent the overcharging which may lead to an explosion due to the user's fault. It can disconnect the circuit automatically and alarm once detecting any malfunction. All the programs of this product were controlled through two way linkage and communication, to achieve the maximum safety and minimize the trouble. All the settings can be configured by users!

### **Internal independent lithium battery balancer**

iMAX B6 Ultimate employs an individual-cell-voltage balancer. It isn't necessary to connect an external balancer for balance charging.

### **Balancing individual cells battery discharging**

During the process of discharging, iMAX B6 Ultimate can monitor and balance each cell of the battery individually. Error message will be indicated and the process will be ended automatically if the voltage of any single one cell is abnormal.

### **Adaptable to various type of lithium battery**

iMAX B6 Ultimate is adaptable to various types of lithium batteries, such as Li-ion, LiPo and the new LiFe series of batteries.

### **Fast and storage mode of lithium battery**

Purposes to charge Lithium battery varies, 'fast' charge reduce the duration of charging, whereas 'store' state can control the final voltage of your battery, so as to store for a long time and protect useful time of the battery.

### **Maximum safety**

Delta-peak sensitivity: The automatic charge termination program based on the principle of the Delta-peak voltage detection. When the battery's voltage exceeds the threshold, the process will be terminated automatically.

### **Automatic charging current limit**

You can set up the upper limit of the charging current when charging your NiCd or NiMH battery; it is useful for the NiMH battery of low impedance and capacity in the 'AUTO' charging mode.

## **SPECIAL FEATURES**

---

### **Capacity limit**

The charging capacity is always calculated as the charging current multiplied by time. If the charging capacity exceeds the limit, the process will be terminated automatically when you set the maximum value.

### **Temperature threshold**

The battery's internal chemical reaction will cause the temperature of the battery to rise. If the temperature limit is reached, the process will be terminated.

This function is available by connecting temperature probe, which is included in the package.

### **Processing time limit:**

You can also limit the maximum process time to avoid any possible defect.

### **Data store/load**

For users convenience, it can store maximum 10 data of different batteries. You can establish the data contains program setting of the battery to charge or discharge. These data can be called back at any time you need and the process can be executed without program setting.

### **Cyclic charging/discharging**

1 to 5 cyclic and continuous process of charge>discharge or discharge>charge is operable for battery refreshing and balancing to stimulate the battery's activity.

### **PC based analysis using USB Communication**

The B6 Ultimate is fitted with a mini USB port on the right-hand side of the case; a USB wire can be connected to this socket in order to link the charger to a PC. "Charger Monitor" Program enable you to view graphs of charge and discharge curves, with a capacity, voltage, temperature and ampere display, and individual curves can be individually suppressed or superimposed to allow a visual comparison of the data.



## SPECIAL FEATURES

### PC based analysis using USB Communication

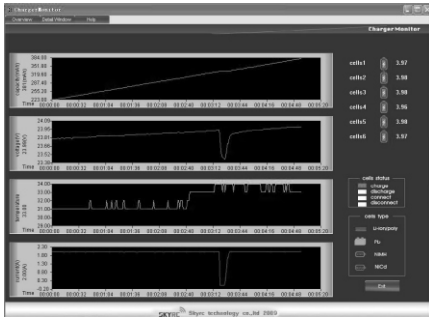

### USB Power Supply



### USB Power Supply

The USB power supply can provide 5V, 1A continue current. You can power your mobile phone, digital camera or even your iPod via the USB power supply.

## **WARNING AND SAFETY NOTES**

---

***These warnings and safety notes are particularly important. Please follow the instructions for maximum safety; otherwise the charger and the battery can be damaged or at worst it can cause a fire.***

---

- ❗ Never leave the charger unattended when it is connected to its power supply. If any malfunction is found, **TERMINATE THE PROCESS AT ONCE** and refer to the operation manual.

---

- ❗ Keep the charger well away from dust, damp, rain, heat, direct sunshine and vibration. Never drop it.

---

- ❗ The allowable input voltage is 11~18V DC

---

- ❗ This charger and the battery should be put on a heat-resistant, nonflammable and nonconductive surface. Never place them on a car seat, carpet or similar. Keep all the inflammable volatile materials away from operating area.

---

- ❗ Make sure you know the specifications of the battery to be charged or discharged to ensure it meets the requirements of this charger. If the program is set up incorrectly, the battery and charger may be damaged. It can cause fire or explosion due to overcharging. This warranty is not valid for any damage or subsequent damage arising as a result of a misuse or failure to observe the procedures outlined in this manual.

---

## WARNING AND SAFETY NOTES

### Standard Battery Parameters

	LiPo	Lilon	LiFe	NiCd	MiMH	Pb
<b>Nominal Voltage</b>	3.7V/cell	3.6V/cell	3.3V/cell	1.2V/cell	1.2V/cell	2.0V/cell
<b>Max Charge Voltage</b>	4.2V/cell	4.1V/cell	3.6V/cell	1.5V/cell	1.5V/cell	2.46V/cell
<b>Storage Voltage</b>	3.8V/cell	3.7V/cell	3.3V/cell	n/a	n/a	n/a
<b>Allowable Fast Charge</b>	≅ 1C	≅ 1C	≅ 4C	1C-2C	1C-2C	≅ 0.4C
<b>Min. Discharge Voltage</b>	≅ 3.0V/cell	≅ 2.5V/cell	≅ 2.0V/cell	≅ 0.85V/cell	≅ 1.0V/cell	≅ 1.75V/cell

Be very careful to choose the correct voltage for different types of battery otherwise you may cause damage to the batteries. Incorrect settings could cause the cells to fire or explode.

## **WARNING AND SAFETY NOTES**

---

- ❗ **Never attempt to charge or discharge the following types of batteries.**
  - A battery pack which consists of different types of cells (including different manufacturers)
  - A battery that is already fully charged or just slightly discharged.
  - Non-rechargeable batteries (Explosion hazard).
  - Batteries that require a different charge technique from NiCd, NiMh, LiPo or Gel cell (Pb, Lead acid).
  - A faulty or damaged battery.
  - A battery fitted with an integral charge circuit or a protection circuit.
  - Batteries installed in a device or which are electrically linked to other components.
  - Batteries that are not expressly stated by the manufacturer to be suitable for the currents the charger delivers during the charge process.
  
- ❗ **Please bear in mind the following points before commencing charging:**
  - Did you select the appropriate program suitable for the type of battery you are charging?
  - Did you set up adequate current for charging or discharging?
  - Have you checked the battery voltage? Lithium battery packs can be wired in parallel and in series, i.e. a 2 cell pack can be 3.7V (in parallel) or 7.4V (in series).
  - Have you checked that all connections are firm and secure?
  - Make sure there are no intermittent contacts at any point in the circuit.
  
- ❗ **Charging**
  - During charge process, a specific quantity of electrical energy is fed into the battery. The charge quantity is calculated by multiplying charge current by charge time. The maximum permissible charge current varies depending on the battery type or its performance, and can be found in the information by the battery manufacturer. Only batteries that are expressly stated to be capable of quick-charge are allowed to be charged at rates higher than the standard charge current.

## **WARNING AND SAFETY NOTES**

---

Connect the battery to the terminal of the charger: red is positive and black is negative. Due to the difference between resistance of cable and connector, the charger can not detect resistance of the battery pack, the essential requirement for the charger to work properly is that the charge lead should be of adequate conductor cross-section, and high quality connectors which are normally gold-plated should be fitted to both ends.

Always refer to the manual by the battery manufacturer pertaining to charging methods, recommended charging current and charging time. Especially, the Lithium battery should be charged according to the charging instruction provided by the manufacturer strictly.

Attention should be paid to the connection of Lithium battery especially.

Do not attempt to disassemble the battery pack arbitrarily.

Please get highlighted that Lithium battery packs can be wired in parallel and in series. In the parallel connection, the battery's capacity is calculated by multiplying single battery's capacity by the number of cells with total voltage stay the same. The voltage's imbalance may cause fire or explosion. Lithium battery is recommended to charge in series.

## WARNING AND SAFETY NOTES

---

### ⚠ Discharging

The main purpose of discharging is to clean residual capacity of the battery, or to reduce the battery' voltage to a defined level. The same attention should be paid to the discharging process as charging. The final discharge voltage should be set up correctly to avoid deep-discharging. Lithium battery can not be discharged to lower than the minimum voltage, or it will cause a rapid loss of capacity or a total failure. Generally, Lithium battery doesn't need to be discharged. Please pay attention to the minimum voltage of Lithium battery to protect the battery.

Some rechargeable batteries have a memory effect. If they are partly used and recharged before the whole charge is accomplished, they remember this and will only use that part of their capacity next time. This is a 'memory effect' It is said that NiCd and NiMH batteries are suffering from memory effect. NiCd has more memory effect than NiMH.

Lithium batteries are recommended to be discharged partially rather than fully discharged. Frequent full discharging should be avoided if possible. Instead, charge the battery more often or use a battery of larger capacity. Full capacity cannot be reached until it has been subjected to 10 or more charge cycles. The cyclic process of charge and discharge will optimize the capacity of battery pack.

# PROGRAM FLOW CHART

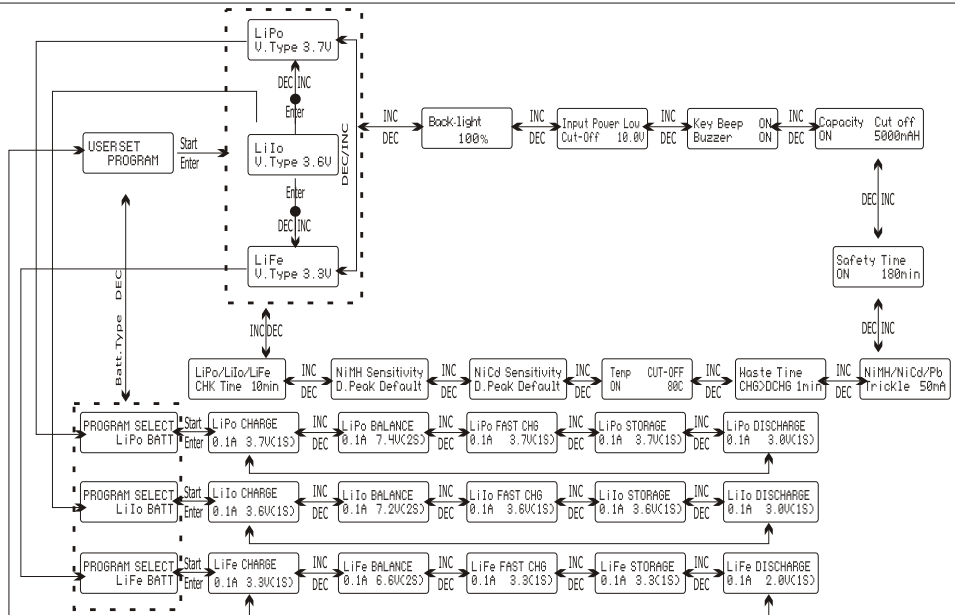

Continue on next page!

# PROGRAM FLOW CHART

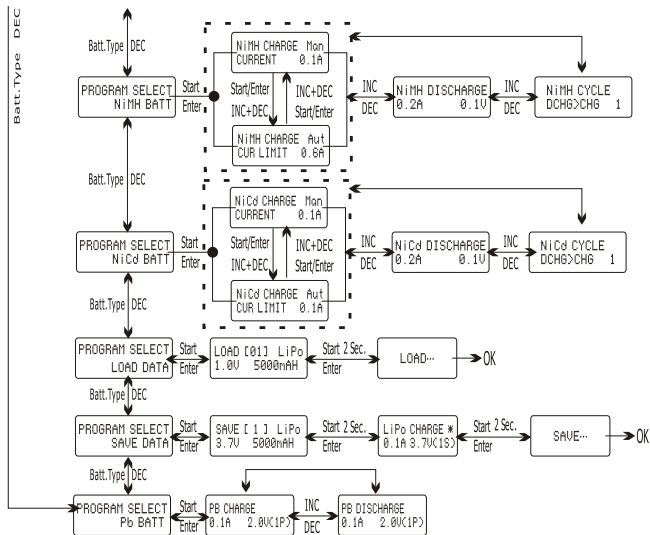



## LITHIUM POLYMER BALANCE CHARGE PROGRAM CONNECTION DIAGRAM

---

### CONNECTING THE CHARGER

IMAX B6 Ultimate comes with male 4mm Bullet connectors attached to the power INPUT cables. These cables are appropriate for attaching directly to most high-quality AC-DC power supply units, such as eFUEL model PSU20A (13.8V, 20A). Also included are large Terminal Clips with matching 4mm female bullet connectors, for attaching directly to 12V car batteries. It is critically important that you use either a fully charged 13.8V car battery or a high quality AC-DC power supply in the range of 11V to 18V DC output, with minimum current rating of 20A to insure reliable performance.



4mm Bullet  
Connectors  
plugging  
to eFUEL power  
supply directly



Using terminal  
clip attaching to  
car battery

### CONNECTING THE BATTERY

Important !!! Before connecting a battery it is absolutely essential to check one last time that you have set the parameters correctly. If the settings are incorrect, the battery may be damaged, and could even burst into flames or explode. To avoid short-circuits between the banana plugs, always connect the charge leads to the charger first, and only then to the battery. Reverse the sequence when disconnecting the pack.

## LITHIUM POLYMER BALANCE CHARGE PROGRAM CONNECTION DIAGRAM

---

### Balance socket:

The balance wire attached to the battery must be connected to the charger with the black wire aligned with the negative marking. Take care to maintain correct polarity! (Wiring diagram: see below.)

This diagram shows the correct way to connect your battery to the iMAX B6 Ultimate while charging in the balance charge program mode only.

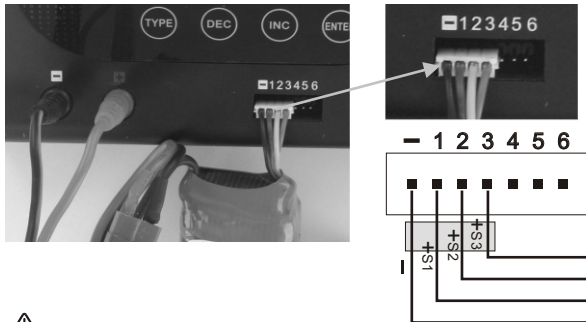

### **WARNING:**

Failure to connect as shown in this diagram will damage this charger.

To avoid short circuit between the charge lead always connect the charge cable to the charger first, then connect the battery. Reverse the sequence when disconnecting.

## INITIAL PARAMETER SETUP (USERS SET UP)

### Initial parameter setup (Users setup)

IMAX B6 Ultimate will be operated with the default value of the essential user settings when it is connected to a 12V battery for the first time. The screen displays the following information in sequence and the user can change the value of parameter on each screen.

When you are willing to alter the parameter value in the program, press **start/enter** key to make it blink then change the value with **Inc** or **Dec** key. The value will be stored by pressing **start/enter** key once.

User setup starting screen.

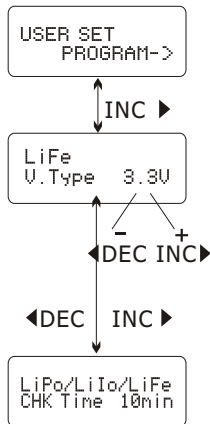

The screen displays the nominal voltage of Lithium battery. There are three kinds of Lithium battery: LiFe(3.3V), Lilo(3.6V) or LiPo(3.7V). This is very important so you have to check the battery carefully and set it up correctly. If it is different from correct value the battery may be exploded during charge process.

IMAX B6 Ultimate recognize the cell count of Lithium battery automatically at the beginning of charge or discharge process to avoid from erroneous setting by user. But deeply discharged battery can be perceived incorrectly. To prevent the error, you can set the time term to verify the cell count by the processor. Normally, 10 minutes are enough to perceive the cell count correctly. For the battery of larger capacity, you may extend the time term. But if you set the time term too long for the battery of smaller capacity, the charge or discharge process can be finished within the time term with the erroneous cell count. This may cause the fatal result.

If the processor recognizes the cell count incorrectly at the beginning of charge or discharge process, you may extend the time. Otherwise, you had better use with the default value.

## INITIAL PARAMETER SETUP (USERS SET UP)

---

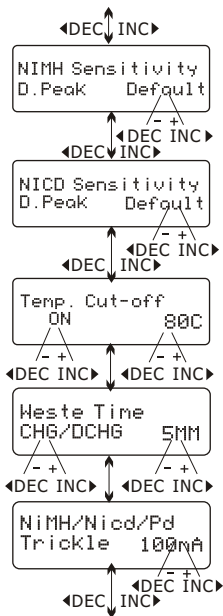

Termination of NiMH and NiCd battery. The effective value ranges from 5 to 20mV per cell. If the trigger voltage is set higher, there is a danger of over charging the battery; if it is set lower, there is a possibility of premature termination. Please refer the technical specification of the battery. (NiCd default: 12mV, NiMH default: 7mV)

An optional feature using temperature probe contacting the surface of battery, the temperature cut-off can be on or off. If it is on, set the maximum temperature at which the charger should allow battery to reach during charge. Once a battery reaches this temperature during charge, the process will be terminated to protect the battery.

The battery is on the cyclic process of charge and discharge can often become warm after charge or discharge period. The program can insert a time delay to occur after each charge and discharge process to allow the battery adequate time to cool down before being subjected to the next process. The value ranges from 1 to 60 minutes.

You can set the trickle charge mode on or off. If it is on, the charger will automatically supply the trickle charge current to achieve the full charge without overheating the battery after fast charge has been terminated.

## INITIAL PARAMETER SETUP (USERS SET UP)

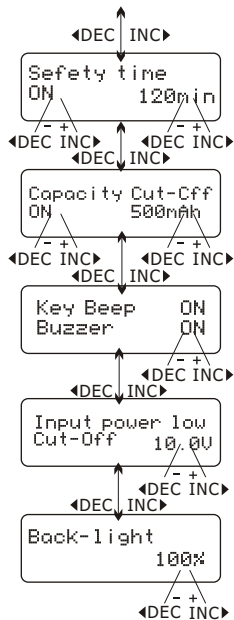

When you start a charge process, the integral safety timer automatically starts running at the same time. This is programmed to prevent overcharge the battery if it proves to be faulty, or if the termination circuit cannot detect the battery full. The value for the safety timer should be generous enough to allow a full charge of the battery.

This program sets the maximum charge capacity that will be supplied to the battery during charge. If the delta-peak voltage is not detected nor the safety timer expired by any reason, this feature will automatically stop the process at the selected capacity value.

The beep sounds at every time pressing the buttons to confirm your action. The beep or melody sounded at various times during operation to alert different mode changes. These audible sounds can be turned on or off.

This program monitors the voltage of input battery. If the voltage drops below the value you set the operation forcibly terminated to protect the input battery.

You can adjust the brightness of LCD screen at the charger.

## LITHIUM BATTERY (LILON/LIPO/LIFE) PROGRAM

### Lithium battery (Lilon/LiPo/LiFe) program

These programs are only suitable for charging and discharging Lithium batteries with a nominal voltage of 3.3V, 3.6V and 3.7V per cell. These batteries need to adopt different charge technique that is termed constant current (CC) and a constant voltage (CV) method. The charge current varies according to the battery capacity and performance.

The Lithium battery is charged at a constant current until it reaches the final charge voltage of 4.2 V per cell (B). After this point the voltage is kept at a constant level, and the residual charge takes the form of a declining current curve (C) until the cut-off point (D) is reached. Charge current =  $C/10$ . At this point the battery can be disconnected from the charger, and is ready for use.

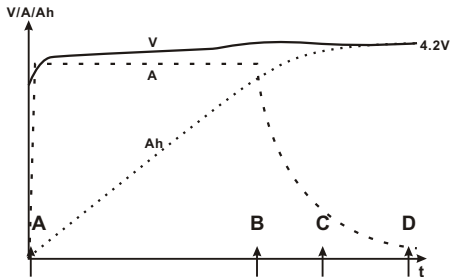

The final voltage of charge process is also very important; it should be precisely matched with the charged voltage of the battery. They are 4.2V for LiPo, 4.1V for Lilo, and 3.6V for LiFe. The charge current and nominal voltage as for cell count set on the charge program must always be correct for the battery to be charged.

When you are willing to alter the parameter value in the program, press start/enter key to make it blink then change the value with Inc> or <Dec key. The value will be stored by pressing start/enter key once.

## CHARGING LITHIUM BATTERY IN THE CHARGE MODE

### Charging lithium battery in the charge mode

This charging mode is for charging Li-Po/Ion/Fe battery without balance lead.

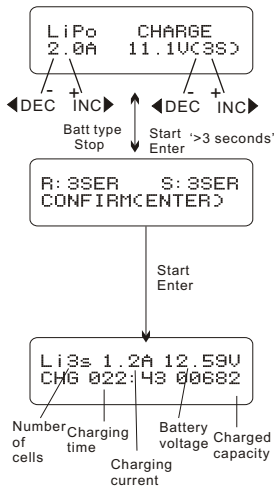

The left side of the first line shows the type of battery you choose. The value on the left of the second line of the charger is current user set. After setting the current and voltage, press START/ENTER key for more than 3 seconds to start the process. (charge current: 0.1-10.0A, voltage: 3.7-22.2V).

This displays the number of cells you set up and the processor detects. "R" shows the number of cells detected by the charger and "S" is the number of cells set by you at the previous screen. If both numbers are identical you can start charging by press START/ENTER button. If not, press BATTTYPE/STOP button to go back to previous screen to carefully check the number of cells of the battery pack before going ahead.

This screen shows the real-time status during charge process. Press BATTTYPE/STOP key once to stop the charge process.

## CHARGING LITHIUM BATTERY IN THE BALANCE MODE

### *Charging lithium battery in the balance mode*

This function is for balancing the voltage of Lithium-polymer battery cells while charging. In the balance mode, the battery needs to have a balance lead to connect to the individual balance port of the charger. And you need to connect the battery's power lead to the output of charger. Charging in this mode is different from the normal modes, because the built-in processor monitors voltage of individual cell and control input current fed into each cell to equalized voltage of individual cell.

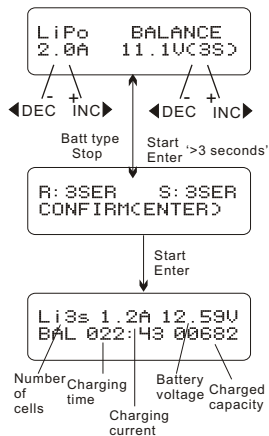

The left side of the first line shows the type of battery you choose. The value on the left of the second line of the charger is current user set, After setting the current and voltage, press START/ENTER key for more than 3 seconds to start the process. (charge current: 0.1-10.0A, voltage: 3.7-22.2V).

This displays the number of cells you set up and the processor detects. "R" shows the number of cells detected by the charger and "S" is the number of cells set by you at the previous screen. If both numbers are identical you can start charging by press START/ENTER button. If not, press BATTTYPE/STOP button to go back to previous screen to carefully check the number of cells of the battery pack before going ahead.

This screen shows the real-time status during charge process. Press BATTTYPE/STOP key once to stop the charge process.



## CHARGING LITHIUM BATTERY IN THE FAST CHARGE MODE

### Charging lithium battery in the fast charge mode

The charging current is getting smaller as the process goes to the near end term of Lithium battery charging. To finish charging process earlier, this program eliminate certain term of CV process. Actually, the charging current will go to 1/5 from the initial value to end the process while the normal charging goes to 1/10 during CV term. The charging capacity may be a bit smaller than normal charging but the process time will be reduced.

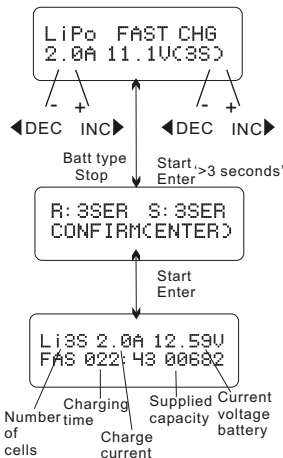

The value on the left side of the second lines sets the charge current. The value on the right side of the second lines sets the battery pack's voltage. After setting current and voltage, press STAR/ENTER for more than 3 seconds to start the process.

This displays the number of cells you set up and the processor detects. "R" shows the number of cells detected by the charger and "S" is the number of cells set by you at the previous screen. If both numbers are identical you can start charging by press START/ENTER button. If not, press BATTTYPE/STOP button to go back to previous screen to carefully check the number of cells of the battery pack before going ahead.

This screen shows the real-time status during charge process. Press BATTTYPE/STOP key once to stop the charge process.

## CHARGING LITHIUM BATTERY IN THE STORAGE MODE

### *Charging lithium battery in the storage mode*

This is for charging or discharging Lithium battery not to be used for the time being. The program will determine to charge or discharge the battery to the certain voltage depending on the voltage of the battery at its initial stage. They are different from the type of the battery, 3.75V for LiIo, 3.85V for LiPo and 3.3V for LiFe per cell. If the voltage of battery at its initial stage is over the voltage level to storage, the program will start to discharge.

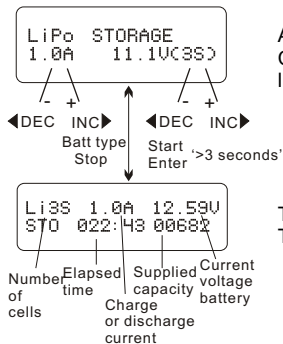

At this screen, you can set up the current and voltage of the battery pack. Charging and discharging will make the batteries come to the voltage level of "storage" state.

This screen shows the real-time status charging. Press BATT TYPE/STOP key once to stop the charge process.

## DISCHARGING OF LITHIUM BATTERY

### Discharging of lithium battery

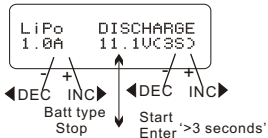

The value of discharge current on the left can not exceed 1C, and the value on the right can not be under the voltage recommended by the manufacturer to avoid deep discharging. Press START/ENTER for more than 3 seconds to start discharging.

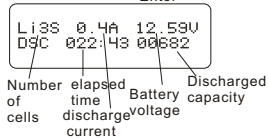

This shows the real-time status of discharging, you can press BATT TYPE/STOP key to stop discharging.

### Voltage balancing and monitoring in the discharge process

The processor monitors voltage of each cell when the battery packs are during its "storage" and "discharging" process. If voltage of any cell is abnormal, iMAX B6 Ultimate will show error message and terminate the program forcibly. So if there is battery damage or disconnection, you can see the error message and press INC to know which cell is damaged.

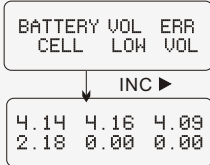

The processor detects voltage of one cell is too low.

The 4th cell was damaged. The value of voltage may be zero if disconnection occurs.

## CHARGING NiCd/NiMH BATTERY IN THE CHARGE MODE

### *Charging NiCd/NiMH battery in the charge mode*

This program charge the battery using the current you set up. In the “auto” state, you should set up the upper limit of the charge current to avoid damage by excessive feeding current. Some batteries of low resistance and capacity can lead to higher current in the “auto” charging mode. But in the manual mode, it will charge with the current you set. You can make it blink in the current field and press INC and DEC simultaneously to swap between Auto and Manual Mode. NOTE: Allowable fast charge current: 1C-2C

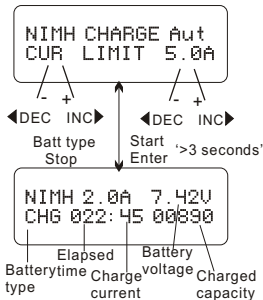

This program is for charging of NiCd/NiMH batteries associated with R/C models applications. You can press START/ENTER key to make it blink and then INC or DEC to change the parameter value. Press START/ENTER key to store the value.

The screen shows the real-time status. Press BATTTYPE/STOP key to end the program. The sound will emitted to indicates the end of program.

## DISCHARGE OF NICD/NIMH BATTERY

### Discharge of NiCd/NiMH battery

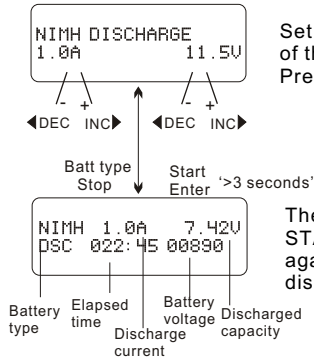

Set discharge current on the left and the final voltage on the right. Range of the discharge current is 0.1-5.0A; range of final voltage is 0.1-25.0V. Press START/ENTER key for more than 3 seconds to start the program.

The screen indicates the discharging state. You can press START/ENTER key to alter discharge current. Press START/ENTER again to store the value. Press BATT TYPE/STOP key to stop discharging. The emitted sound alerts the end of discharging.

## CHARGE/DISCHARGE AND DISCHARGE/CHARGE CYCLE OF NICD/NIMH BATTERY

### *Charge/discharge and discharge/charge cycle of NiCd/NiMH battery*

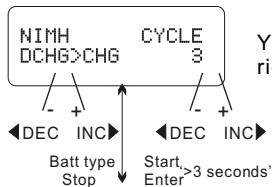

You can set up sequence on the left and the number of cycles on the right. Range of the cycle number is 1-5.

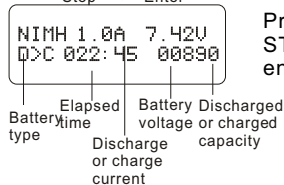

Press BATT TYPE/STOP key to stop program, you can press START/ENTER key to alter charge current. The sound indicates the end of program.

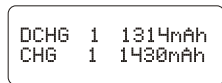

When it approaches to the end, you can see the capacity of the battery being charged or discharged. You can press INC or DEC key to display result of each cycle.

## CHARGING Pb (LEAD-ACID) BATTERY IN THE CHARGE MODE

### *Charging Pb (lead-acid) battery in the charge mode*

This program is only suitable for charging Pb (lead-acid) battery with nominal voltage from 2 to 24V. Pb (lead-acid) battery is completely different from NiCd/NiMH battery. These batteries can only deliver current lower in comparison to their capacity. The same restriction applies to the charging process. Consequently, the optimum charge current can only be 1/10 of the capacity. Pb battery can not be used for fast-charging, please follow the instructions provided by the battery manufacturer. Due to the chemistry characteristic of Pb battery, the cut off point may be difficult to detect sometimes. We recommend user to use CAPACITY CUTOFF feature to protect the battery. You can press START/ENTER key to make it blink and alter the value of parameters using INC or DEC key, press START/ENTER key to store the value.

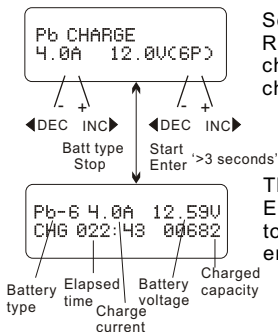

Set up the charge current on the left and nominal voltage on the right. Range of current is 0.1-10.0A, the voltage should match the battery being charged. Press START/ENTER key for more than 3 seconds to start charging.

The screen displays the real-time discharging status. Press START/ENTER key to alter discharge current. Press START/ENTER key again to store the parameter value you set. Press BATT TYPE/STOP key to end the program.

## DISCHARGING OF THE PB BATTERY

### *Discharging of the Pb battery*

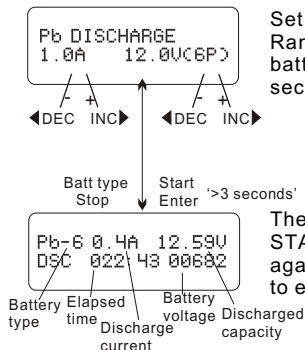

Set up the discharge current on the left and nominal voltage on the right. Range of discharge current is 0.1-5.0A, the voltage should match the battery being charged. Press START/ENTER key for more than 3 seconds to start charging.

The screen displays the real-time discharging status. Press START/ENTER key to alter discharge current. Press START/ENTER key again to store the parameter value you set. Press BATT TYPE/STOP key to end the program.



## STORAGE DATA PROGRAM

### Storage data program

For your convenience, iMAX B6 Ultimate has a data storage and load program. It can store ten batteries data representing the respective specifications of batteries. You can call back the data when charging or discharging without setting up the program again. Press START/ENTER key to make it blink, and use INC or DEC to set up the parameter.

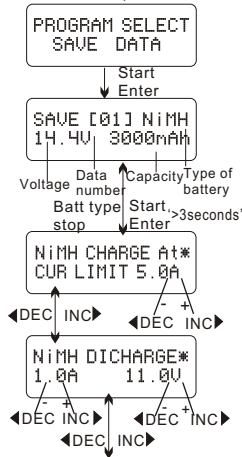

Setting of the parameter in the screen will not affect the charge and discharge process. They just present the specification of the battery. The example is NiMH battery pack, including 12 cells, the capacity is 3000mAh.

Set up the charge current in the manual mode, or current limit in the auto mode. Press INC and DEC key simultaneously to make the current field blink to switch the charge mode.

Set up the discharge current and final voltage.

## LOAD DATA PROGRAM

---

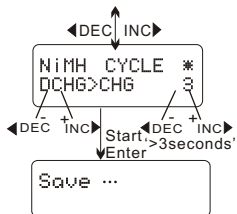

Set up the charge/ discharge sequence and cycle number.

Saving the data

### ***Load data program***

This program is to load the data stored at the "save data" program. Press START/ENTER key to make the data field blink and press INC or DEC for more than 3 seconds to load the data.

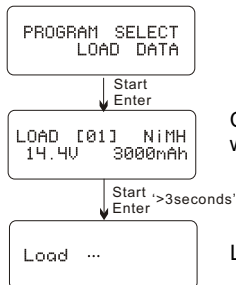

Choose the data number you want to call back. The data you want to call back will be displayed.

Loading the data.

## VARIOUS INFORMATION IN THE PROGRAM

### *Various information in the program*

You can inquire various information on the LCD screen during the charging and discharging process. Press DEC key, the charger will display users' setting. You can press INC key to monitor voltage of each cell while the battery's balance lead is connected to the charger.

End Voltage  
12.60V(3S)

It comes to the final voltage when the program ended.

Capacity Cut-Off  
ON 5000mAh

Displayed capacity cut-off function is turn on and the setting value of capacity.

Safety Time  
ON 200min

Displayed safety timer is turn on and duration of time in minutes.

Temp Cut-Off  
OFF 80c

Displayed temperature cut-off function is turn on.

Ext. Temp 26C

The external temperature is displayed when the temperature probe is used.

IN Power Voltage  
12.56V

Present input voltage.

C1: 4.12 C2: 4.09V  
C3: 4.09 C4: 4.10V

The battery is connected with balance lead, you can check voltage of each cell in the battery pack.

C5: 4.18 C6: 4.15V  
C7: 0.00 C8: 0.00V

## WARNING AND ERROR MESSAGE

---

IMAX B6 Ultimate incorporates a various functions of protective and monitoring the system to verify functions and the state of its electronics. In any case of occurring error, the screen displays the cause of error that is self-explanatory with audible sound.

REVERSE POLARITY	Incorrect polarity connected.
CONNECTION BREAK	Battery connection is interrupted.
SHORT ERR	Short-circuit of the output termination.
INPUT VOL ERR	Input voltage wrong.
VOL SELECT ERR	The voltage of the battery pack has been selected incorrectly!
BREAK DOWN	The charger has malfunctioned for some reason. Seek professional advice.
BATTERY CHECK LOW VOLTAGE	The voltage is lower than which is set. Please check the number of cells in the battery pack.
BATTERY CHECK HIGH VOLTAGE	The voltage is higher than which is set. Please check the number of cells in the battery pack.
BATTERY VOLTAGE CELL LOW VOL	Voltage of one cell in the battery pack is too low, please check the voltage of each cell.
BATTERY VOLTAGE CELL HIGH VOL	Voltage of one cell in the battery pack is too high; please check the voltage of each cell.
BATTERY VOL ERR CELL CONNECT	Wrong connection of the connector detected; please check the connector and cable.
TEMP OVER ERR	The internal temperature of the unit goes too high. Cool down the unit.
CONTROL FAILURE	The processor cannot control the feeding current, please repair it.

## RECOMMENDED ACCESSORIES



20A DC  
Power Supply



Temperature  
Sensor Cable

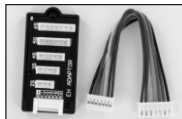

EH Adaptor

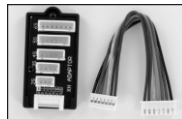

XH Adaptor

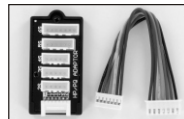

HP/PQ Adaptor

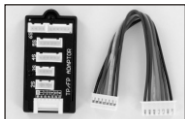

TP/FP Adaptor



Dean charging cable



Tamiya charging  
cable



TRAXXAS charging  
cable



JST/BEC charging  
cable



Glow charging cable



Bullet charging cable



EC3 charging cable



Crocodile clip  
charging cable



Futaba RX  
charging cable

## CONFORMITY DECLARATION

---

IMAX B6 Ultimate satisfy all relevant and mandatory EC directives and FCC Part 15 Subpart B: 2008.

For EC directives:

The product has been tested to meet the following technical standards:

Test Standards	Title	Result
EN 55014-1:2006	Electromagnetic compatibility-Requirements for household appliances, electric tools and Similar apparatus - Part 1: Emission	Conform
EN55014-2:1997+A1:2001	Electromagnetic compatibility-Requirements for household appliances, electric tools and Similar apparatus - Part 2: Immunity-Product family standard	Conform
EN61000-6-1(2007)	Electromagnetic compatibility (EMC) – Part 6-1: Generic standards - Immunity for residential, commercial and light-industrial environments	Conform
EN61000-6-3(2007)	Electromagnetic compatibility (EMC) – Part 6-3: Generic standards-Emission standard for residential, commercial and light-industrial environments.	Conform



This symbol means that you must dispose of electrical from the General household waste when it reaches the end of its useful life.

Take your charger to your local waste collection point or recycling centre.

This applies to all countries of the European Union, and to other European countries with a separate waste collection system.

## MAXIMUM CIRCUIT POWER CHART

### **Maximum circuit power chart**

The actual amount of charge current feeding to the battery is automatically be limited to 200 Watts, so not to exceed the charger's maximum rated charging power.

The maximum discharge power is approximately 25 Watts. The discharge current delivered to the charger is limited by charger's internal thermal sensor for maximum discharge current. If the internal temperature over 80 Celsius, the charger will be cutoff and "TEMPOVER ERR" will show on the LCD. In this case, please decrease discharge current.

Please refer following chart for maximum charging/discharging current.

**Maximum Circuit Power Chart**

Battery Type	No. of Cells	Rated Voltage(V)	Max Charge Voltage(V)	Charge Current (A) Charging Power 200W	Discharge Current (A) Discharging Power 25W
NiCd/NiM	2	2.4	3.0	10.0	5.0
	3	3.6	4.5	10.0	5.0
	4	4.8	6.0	10.0	4.2
	5	6.0	7.5	10.0	3.3
	6	7.2	9.0	10.0	2.8
	7	8.4	10.5	10.0	2.4
	8	9.6	12.0	10.0	2.1
	9	10.8	13.5	10.0	1.9
	10	12.0	15.0	10.0	1.7
	11	13.2	16.5	10.0	1.5
	12	14.4	18.0	10.0	1.4
	13	15.6	19.5	10.0	1.3
	14	16.8	21.0	10.0	1.2
	15	18.0	22.5	10.0	1.1
	16	19.2	24.0	10.0	1.0
	17	20.4	25.5	9.8	1.0
	18	21.6	27.0	9.2	0.9

## MAXIMUM CIRCUIT POWER CHART

Battery Type	No. of Cells	Rated Voltage(V)	Max Charge Voltage(V)	Charge Current (A) Charging Power 200W	Discharge Current (A) Discharging Power 25W
<b>LiPo</b>	1S	3.7	4.2	10.0	5.0
	2S	7.4	8.4	10.0	3.0
	3S	11.1	12.6	10.0	2.0
	4S	14.8	16.8	10.0	1.5
	5S	18.5	21.0	10.0	1.2
	6S	22.2	25.2	9.0	1.0
<b>Lilon</b>	1S	3.6	4.1	10.0	5.0
	2S	7.2	8.2	10.0	3.0
	3S	10.8	12.3	10.0	2.0
	4S	14.4	16.4	10.0	1.5
	5S	18.0	20.5	10.0	1.2
	6S	21.6	24.6	9.3	1.0
<b>LiFe</b>	1S	3.3	3.6	10.0	5.0
	2S	6.6	7.2	10.0	3.5
	3S	9.9	10.8	10.0	2.3
	4S	13.2	14.4	10.0	1.7
	5S	16.5	18.0	10.0	1.4
	6S	19.8	21.6	10.0	1.2
<b>Pb</b>		6.0	7.4	10.0	3.4
		8.0	9.8	10.0	2.5
		10.0	12.3	10.0	2.0
		12.0	14.8	10.0	1.7
		14.0	17.2	10.0	1.5
		16.0	19.7	10.0	1.3
		18.0	22.1	10.0	1.1
		20.0	24.6	10.0	1.0
		22.0	27.1	9.1	0.9
		24.0	29.5	8.3	0.8



## SPECIFICATION

Operating voltage range	DC 11.0~18.0 Volt
Circuit power	Max. Charge power 200Watts Max. Discharge power 25Watts
Charge current range	0.1~10.0A
Discharge current range	0.1~5.0A
Current drain for balancing Li-Po/Ion/Fe	200mA/cell
Li-ion/Fe/Polymer cell count	1~6cells
NiCd/NiMH battery cell count	1~18cells
Pb battery voltage	2V~24V
Net weight	607g
Dimension	150x116.5x53mm

### ***Liability exclusion***

This charger is designed and approved exclusively for use with the types of battery stated in these Instruction Manual. SkyRC accepts no liability of any kind if the charger is used for any purpose other than that stated.

We are unable to ensure that you follow the instructions supplied with the charger, and we have no control over the methods you employ for using, operating and maintaining the device. For this reason we are obliged to deny all liability for loss, damage or costs which are incurred due to the incompetent or incorrect use and operation of our products, or which are connected with such operation in any way. Unless otherwise prescribed by law, our obligation to pay compensation, regardless of the legal argument employed, is limited to the invoice value of those SkyRC products which were immediately and directly involved in the event in which the damage occurred.

## COMMONLY USED TERMS

---

### *Commonly used terms*

**Final charge voltage:** the voltage at which the battery's charge limit (capacity limit) is reached. The charge process switches from a high current to a low maintenance rate (trickle charge) at this point. From this point on further high current charging would cause overheating and eventual terminal damage to the pack.

**Final discharge voltage:** the voltage at which the battery's discharge limit is reached. The chemical composition of the batteries determines the level of this voltage. Below this voltage the battery enters the deep discharge zone. Individual cells within the pack may become reverse polarised in this condition, and this can cause permanent damage.

**A, mA:** unit of measurement relating to charge or dis-charge current.  $1000 \text{ mA} = 1 \text{ A}$  (A=Ampere, mA=Milliampere)

**Ah, mAh:** unit of measurement for the capacity of a battery (Amperes x time unit; h = hour). If a pack is charged for one hour at a current of 2A, it has been fed 2Ah of energy. It receives the same quantity of charge (2Ah) if it is charged for 4 hours at 0.5 A, or 15 minutes (=1/4 h) at 8 A.

**'C'-rating:** Capacity is also referred to as the 'C' rating. Some battery suppliers recommend charge and discharge currents based on the battery 'C' rating. A battery's '1C' current is the same number as the battery's rated capacity number, but noted in mA or amps. A 600mAh battery has a 1C current value of 600mA, and a 3C current value of (3 x 600mA) 1800mA or 1.8A. The 1C current value for a 3200mAh battery would be 3200mA (3.2A).

## WARRANTY AND SERVICE

**Nominal voltage(V):** The nominal voltage of the battery pack can be determined as follows;

- NiCd or NiMH: multiply the total number of cells in the pack by 1.2. A 8-cell pack will have a nominal voltage of 9.6 volts (8x1.2).
- LiPo: multiply the total number of cells in the pack by 3.7. A 3-cell LiPo wired in series will have a nominal voltage of 11.1 volts (3x3.7).
- Lilo: multiply the total number of cells in the pack by 3.6. A 2-cell Lilo wired in series will have a nominal voltage of 7.2 volts (2x3.6).
- LiFe: multiply the total number of cells in the pack by 3.3. A 4-cell Lilo wired in series will have a nominal voltage of 13.2 volts (4x3.3).

If the nominal voltage of the battery is not printed on the battery's label, consult your battery manufacturer or supplier. Do not guess the rated voltage of battery.

### ***Warranty and service***

We guarantee this product to be free of manufacturing and assembly defects for a period of one year from the time of purchase. The warranty only applies to material or operational defects, which are present at the time of purchase. During that period, we will repair or replace free of service charge for products deemed defective due to those causes.

You will be required to produce proof of purchase (invoice or receipt). This warranty is not valid for any damage or subsequent damage arising as a result of misuse, modification or as a result of failure to observe the procedures outlined in this manual.

**iMAX**

All specifications and figures are subject to change without notice.  
Printed in China ©2010

